

Annex C – Site Access Drawings

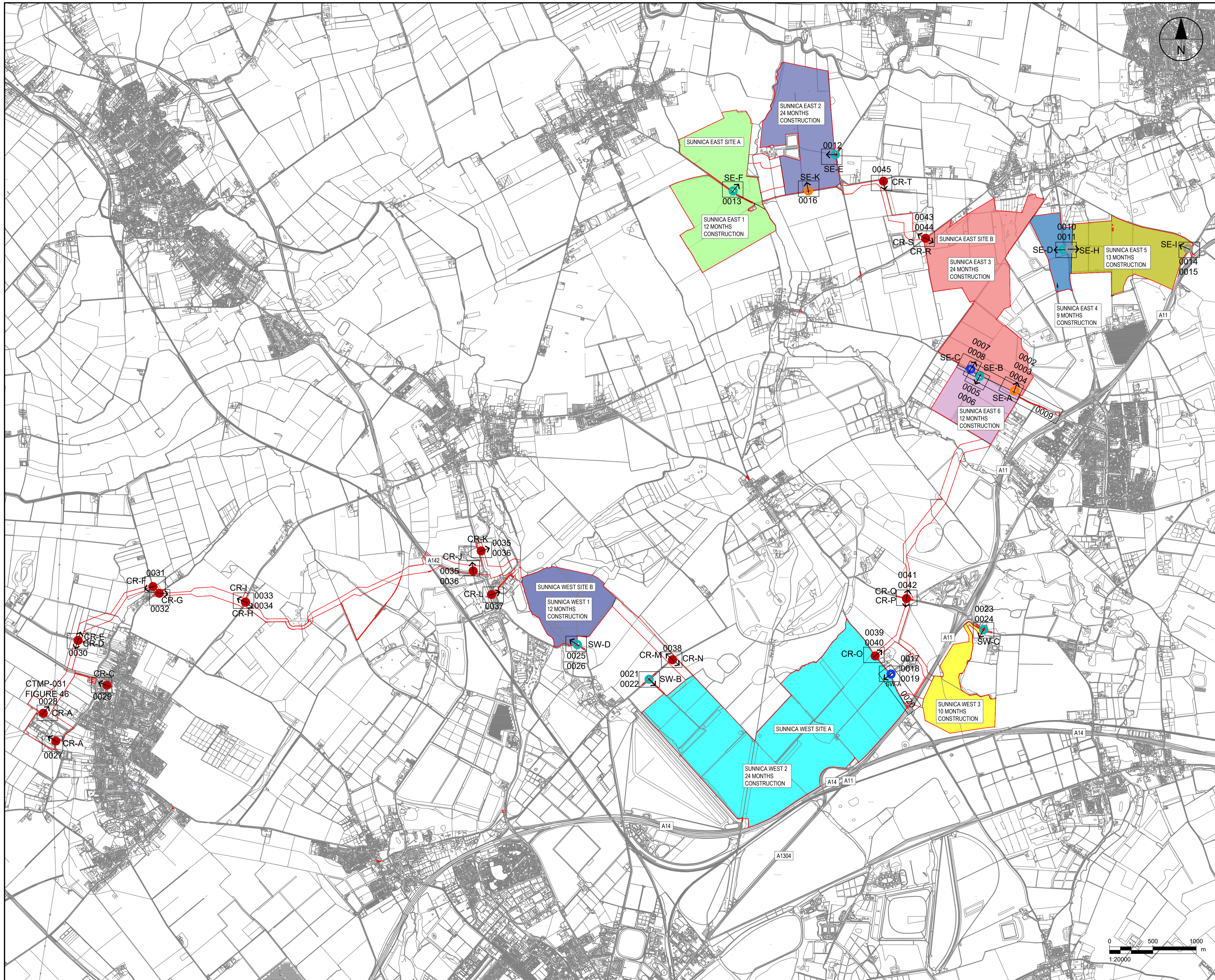

SUNNICA Ltd

AECOM
AECOM House, 63-77 Victoria Street,
St. Albans, Hertfordshire, AL1 3ER
+44(0)1727 535000 tel
+44(0)1727 535099 fax
www.aecom.com

- ALL DIMENSIONS ARE IN METRES UNLESS NOTED OTHERWISE
- ALL JUNCTION LAYOUTS AREA INDICATIVE

- PRIMARY ACCESS: CONSTRUCTION OPERATION AND DECOMMISSIONING.
- CRANE / AIL'S ACCESS: CONSTRUCTION, DECOMMISSIONING AND FOR EMERGENCY VEHICLES IN OPERATION ONLY.
- SECONDARY ACCESS: CONSTRUCTION AND DECOMMISSIONING ONLY.
- SECONDARY ACCESS: CONSTRUCTION OPERATION AND DECOMMISSIONING.
- SECONDARY ACCESS: CONSTRUCTION, OPERATION AND DECOMMISSIONING (NOT FOR HGV).
- SECONDARY ACCESS: CONSTRUCTION, DECOMMISSIONING AND FOR EMERGENCY VEHICLES IN OPERATION ONLY.
- SECONDARY ACCESS: OPERATION ONLY
- CABLE CORRIDOR SITE ACCESS
- ORDER LIMITS
- 0001 SHEET NUMBER LOCATIONS

I/R	DATE	DESCRIPTION
D	2022-11-28	MINOR UPDATE DEADLINE 3A
C	2022-11-11	REDLINE BOUNDARY UPDATE
B	2022-10-05	SECOND ISSUE MINOR UPDATE
A	2022-09-23	FIRST ISSUE



60589004

SUNNICA EAST SITE A AND B AND SUNNICA WEST SITE A AND B ACCESS LOCATIONS

ACM-60589004-AMR-DR-001

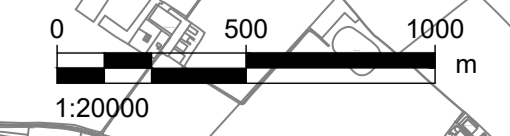

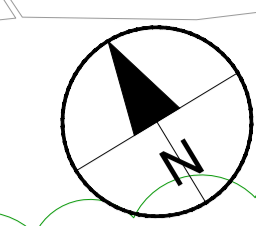
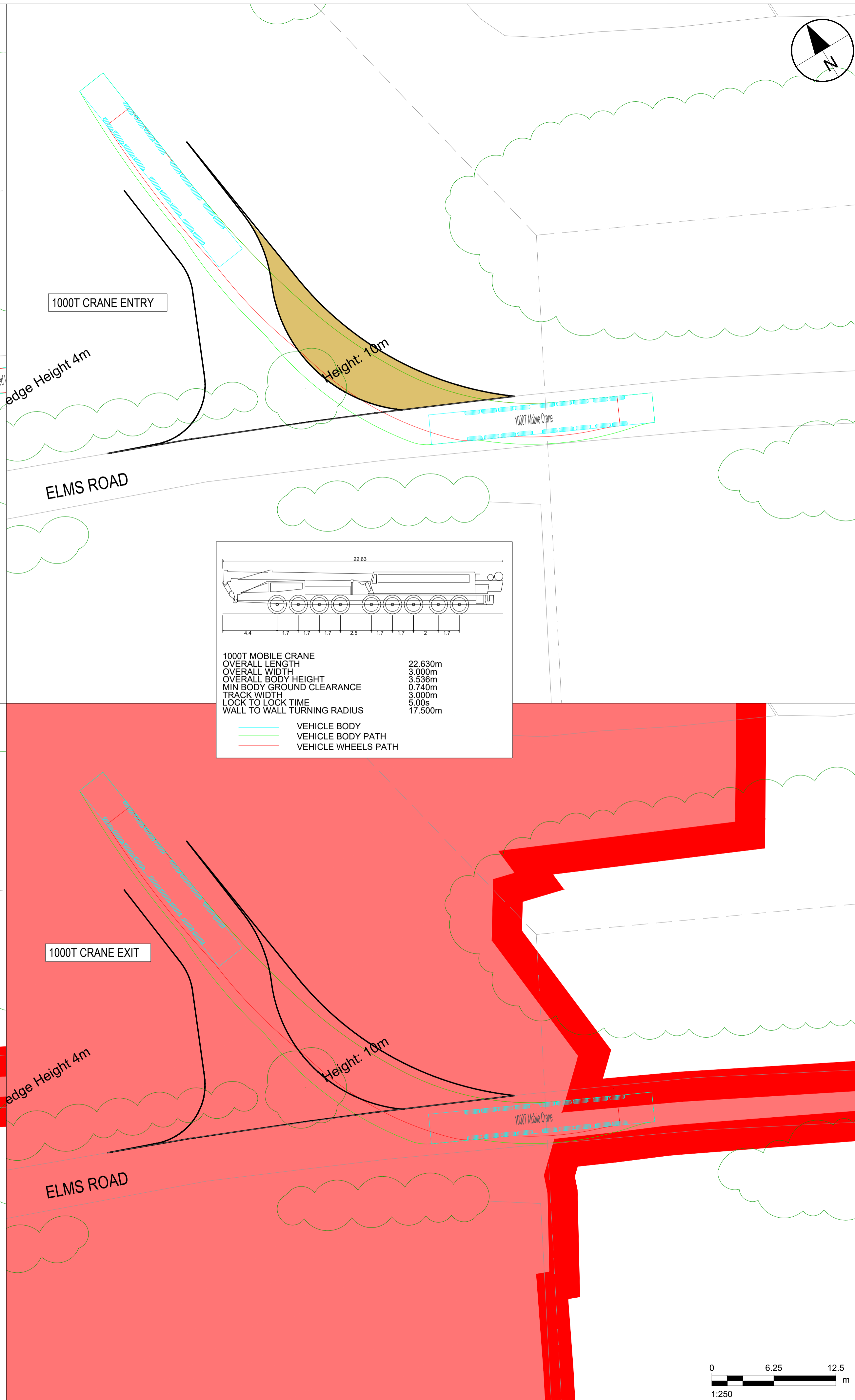
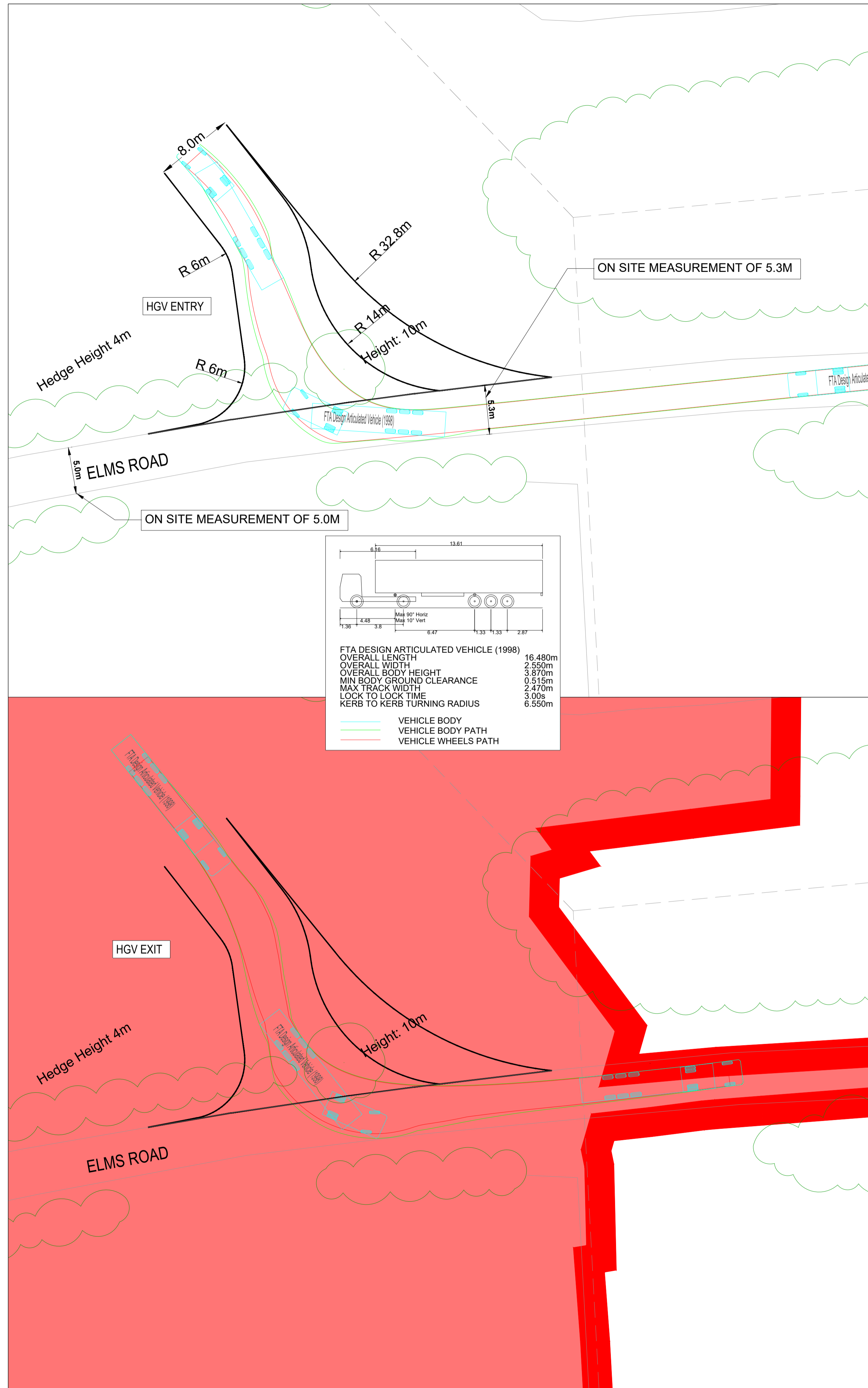

AECOM
AECOM House, 63-77 Victoria Street,
St. Albans, Hertfordshire, AL1 3ER
+44(0)1727 535000 tel
+44(0)1727 535099 fax
www.aecom.com

1. ALL DIMENSIONS ARE IN METRES UNLESS NOTED OTHERWISE
2. ALL JUNCTION LAYOUTS AREA INDICATIVE
3. DESIGN BASED ON TOPOGRAPHIC SURVEY UNDERTAKEN BY "ABOVE SURVEYING" IN APRIL 2019
4. ORDER LIMITS ARE TO THE OUTER EDGE OF THE RED LINE, WHICH IS AS PER PUBLISHED IN THE DCO DOCUMENTATION.
5. ON-SITE MEASUREMENTS RECORDED BY AECOM ON 05/08/2022.

- ORDER LIMITS
- LARGE VEHICLE OVER-SAIL AREA
- INDICATIVE JUNCTION LAYOUT

SUNNICA EAST SITE B (SE-A) - SITE ACCESS A SECONDARY ACCESS: CONSTRUCTION, OPERATIONAL (EMERGENCY USE ONLY) AND DECOMMISSIONING.

PEAK NUMBER OF DAILY HGV'S ACROSS SITE ACCESSES A,B AND C: 22 HGV'S IN MONTH 14 OF THE CONSTRUCTION PERIOD.

AVERAGE DAILY HGV'S ACROSS SITE ACCESSES A,B AND C: 12 HGV'S DURING THE CONSTRUCTION PERIOD FOR 24 MONTHS.

TRAFFIC REGULATION MEASURES
TO PROVIDE SAFE ENTRY AND EGRESS OF THE SITE ACCESS, TEMPORARY TRAFFIC SIGNALS AND TEMPORARY SPEED LIMIT REDUCTIONS ARE PROPOSED WHILST THE SITE ACCESS IS IN USE DURING THE CONSTRUCTION PERIOD. THESE ARE SHOWN ON SHEET NUMBER 60589004-TRM-TM-012 AND 60589004-TRM-TM-013 IN THE TRAFFIC REGULATION MEASURES PLAN TEMPORARY MEASURES.

I/R	DATE	DESCRIPTION
C	2022-11-28	MINOR UPDATE DEADLINE 3A
B	2022-11-11	SECOND ISSUE
A	2022-09-23	FIRST ISSUE



60589004

SUNNICA EAST SITE B, (SE-A) SITE ACCESS A ELMS ROAD

ACM-60589004-AMR-DR-0002

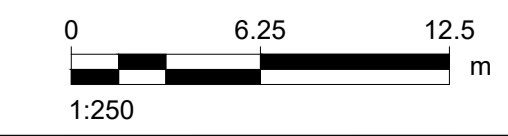

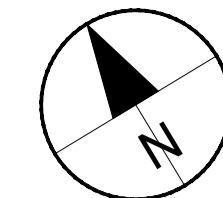
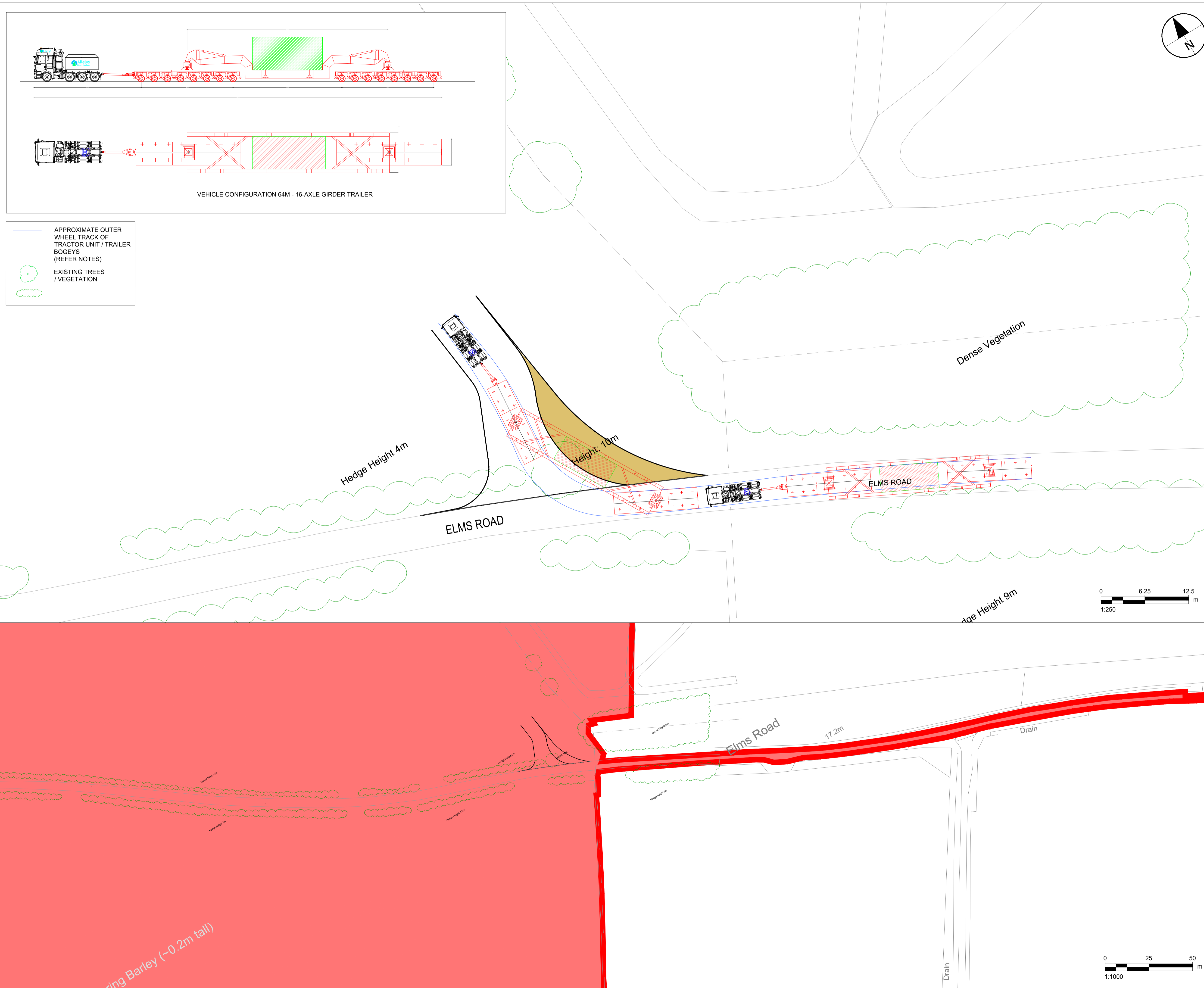

AECOM
 AECOM House, 63-77 Victoria Street,
 St. Albans, Hertfordshire, AL1 3ER
 +44(0)1727 535000 tel
 +44(0)1727 535099 fax
 www.aecom.com

1. ALL DIMENSIONS ARE IN METRES UNLESS NOTED OTHERWISE
2. ALL JUNCTION LAYOUTS AREA INDICATIVE
3. DESIGN BASED ON TOPOGRAPHIC SURVEY UNDERTAKEN BY "ABOVE SURVEYING" IN APRIL 2019.
4. ORDER LIMITS ARE TO THE OUTER EDGE OF THE RED LINE, WHICH IS AS PER PUBLISHED IN THE DCO DOCUMENTATION.

- ORDER LIMITS
- LARGE VEHICLE OVER-SAIL AREA
- INDICATIVE JUNCTION LAYOUT

SUNNICA EAST SITE B (SE-A) - SITE ACCESS A SECONDARY ACCESS: CONSTRUCTION, OPERATIONAL (EMERGENCY USE ONLY) AND DECOMMISSIONING. IN USE DURING THE CONSTRUCTION PERIOD FOR 24 MONTHS.

TO PROVIDE SAFE ENTRY AND EGRESS OF THE SITE ACCESS, TEMPORARY TRAFFIC SIGNALS AND TEMPORARY SPEED LIMIT REDUCTIONS ARE PROPOSED WHILST THE SITE ACCESS IS IN USE DURING THE CONSTRUCTION PERIOD. THESE ARE SHOWN ON SHEET NUMBER 60589004-TRM-TM-012 AND 60589004-TRM-TM-013 IN THE TRAFFIC REGULATION MEASURES PLAN TEMPORARY MEASURES.

I/R	DATE	DESCRIPTION
C	2022-11-28	MINOR UPDATE DEADLINE 3A
B	2022-11-11	SECOND ISSUE
A	2022-09-23	FIRST ISSUE



60589004

SUNNICA EAST SITE B,
 (SE-A) SITE ACCESS A
 ELMS ROAD

ACM-60589004-AMR-DR-0003

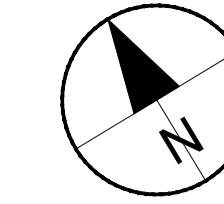
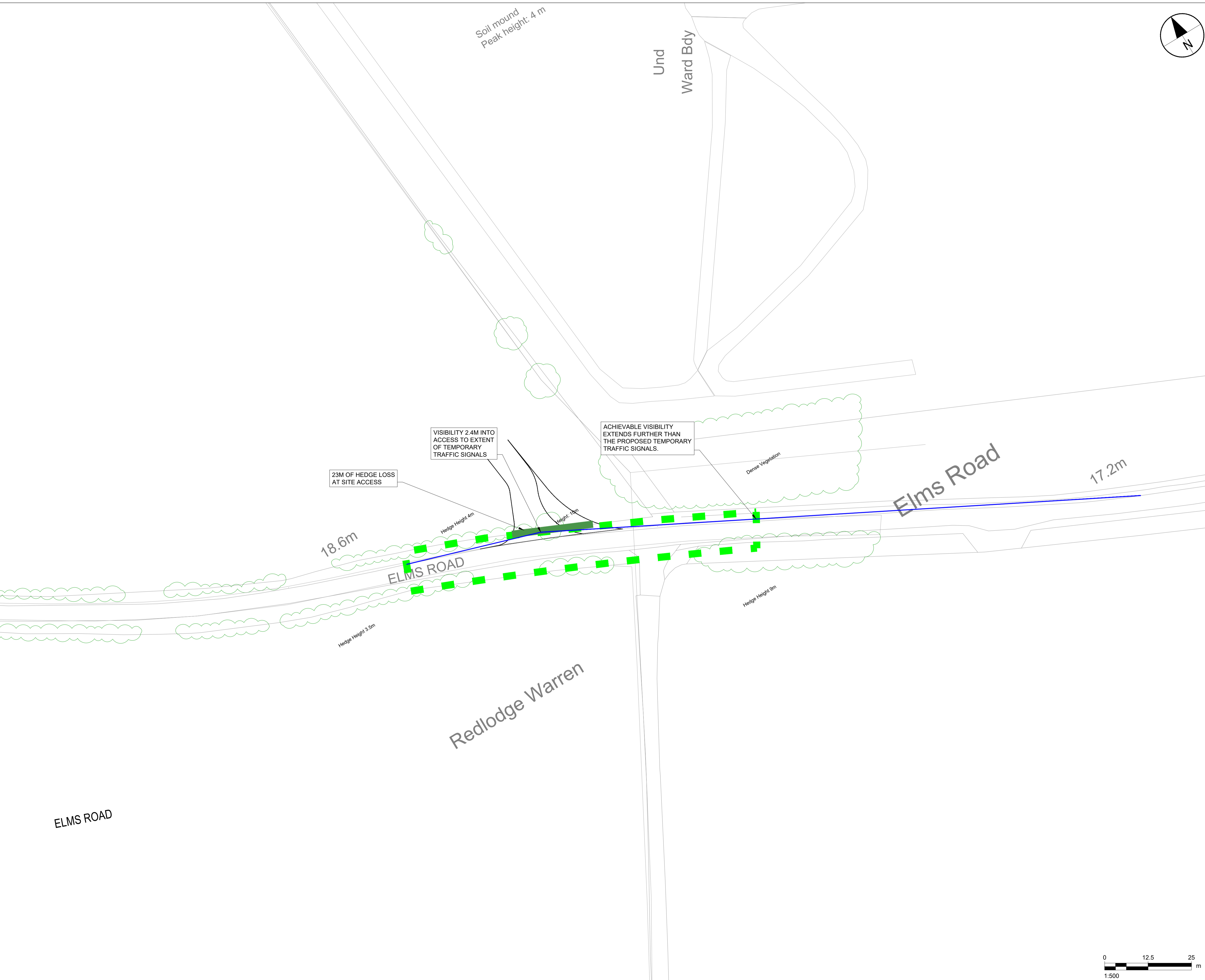

SUNNICA Ltd

AECOM
 AECOM House, 63-77 Victoria Street,
 St. Albans, Hertfordshire, AL1 3ER
 +44(0)1727 535000 tel
 +44(0)1727 535099 fax
 www.aecom.com

1. ALL DIMENSIONS ARE IN METRES UNLESS NOTED OTHERWISE
2. ALL JUNCTION LAYOUTS AREA INDICATIVE
3. DESIGN BASED ON TOPOGRAPHIC SURVEY UNDERTAKEN BY "ABOVE SURVEYING" IN APRIL 2019.
4. ORDER LIMITS ARE TO THE OUTER EDGE OF THE RED LINE, WHICH IS AS PER PUBLISHED IN THE DCO DOCUMENTATION.
5. ON-SITE MEASUREMENTS RECORDED BY AECOM ON 05/08/2022.

- INDICATIVE JUNCTION LAYOUT
- VEGETATION REMOVAL REQUIRED
- TEMPORARY TRAFFIC SIGNALS
- ACHIEVABLE SITE ACCESS VISIBILITY

TRAFFIC REGULATION MEASURES
 TO PROVIDE SAFE ENTRY AND EGRESS OF THE SITE ACCESS, TEMPORARY TRAFFIC SIGNALS AND TEMPORARY SPEED LIMIT REDUCTIONS ARE PROPOSED WHILST THE SITE ACCESS IS IN USE DURING THE CONSTRUCTION PERIOD. THESE ARE SHOWN ON SHEET NUMBER 60589004-TRM-TM-012 AND 60589004-TRM-TM-013 IN THE TRAFFIC REGULATION MEASURES PLAN TEMPORARY MEASURES.

I/R	DATE	DESCRIPTION
B	2022-11-28	MINOR UPDATE DEADLINE 3A
A	2022-11-11	FIRST ISSUE



60589004

SUNNICA EAST SITE B,
 SITE ACCESS A (SE-A), ELMS ROAD
 TEMPORARY TRAFFIC SIGNALS
 AND VISIBILITY
SHEET NUMBER

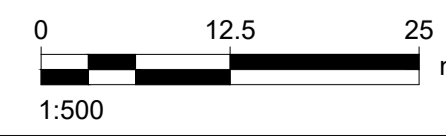

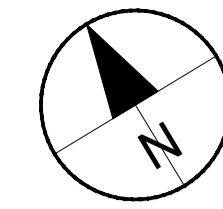
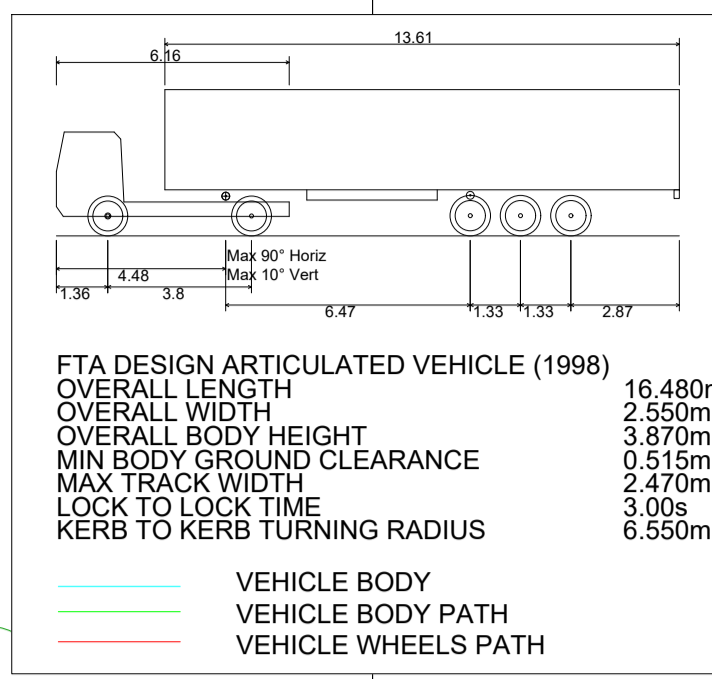

AECOM
 AECOM House, 63-77 Victoria Street,
 St. Albans, Hertfordshire, AL1 3ER
 +44(0)1727 535000 tel
 +44(0)1727 535099 fax
 www.aecom.com

1. ALL DIMENSIONS ARE IN METRES UNLESS NOTED OTHERWISE
2. ALL JUNCTION LAYOUTS AREA INDICATIVE
3. DESIGN BASED ON TOPOGRAPHIC SURVEY UNDERTAKEN BY "ABOVE SURVEYING" IN APRIL 2019.
4. ORDER LIMITS ARE TO THE OUTER EDGE OF THE RED LINE, WHICH IS AS PER PUBLISHED IN THE DCO DOCUMENTATION.
5. ON-SITE MEASUREMENTS RECORDED BY AECOM ON 05/08/2022.

- ORDER LIMITS
- INDICATIVE JUNCTION LAYOUT

SUNNICA EAST SITE B (SE-B) - SITE ACCESS B
 SECONDARY ACCESS, CONSTRUCTION, OPERATIONAL AND DECOMMISSIONING.

PEAK NUMBER OF DAILY HGV'S ACROSS SITE ACCESSES A,B AND C: 22 HGV'S IN MONTH 14 OF THE CONSTRUCTION PERIOD.

AVERAGE DAILY HGV'S ACROSS SITE ACCESSES A,B AND C: 12 HGV'S DURING THE CONSTRUCTION PERIOD FOR 24 MONTHS.

TO PROVIDE SAFE ENTRY AND EGRESS OF THE SITE ACCESS, TEMPORARY TRAFFIC SIGNALS AND TEMPORARY SPEED LIMIT REDUCTIONS ARE PROPOSED WHILST THE SITE ACCESS IS IN USE DURING THE CONSTRUCTION PERIOD. THESE ARE SHOWN ON SHEET NUMBER 60589004-TRM-TM-012 AND 60589004-TRM-TM-013 IN THE TRAFFIC REGULATION MEASURES PLAN TEMPORARY MEASURES.

I/R	DATE	DESCRIPTION
C	2022-11-28	MINOR UPDATE DEADLINE 3A
B	2022-11-11	SECOND ISSUE
A	2022-09-23	FIRST ISSUE



60589004

SUNNICA EAST SITE B,
 (SE-B) SITE ACCESS B
 ELMS ROAD

ACM-60589004-AMR-DR-0005

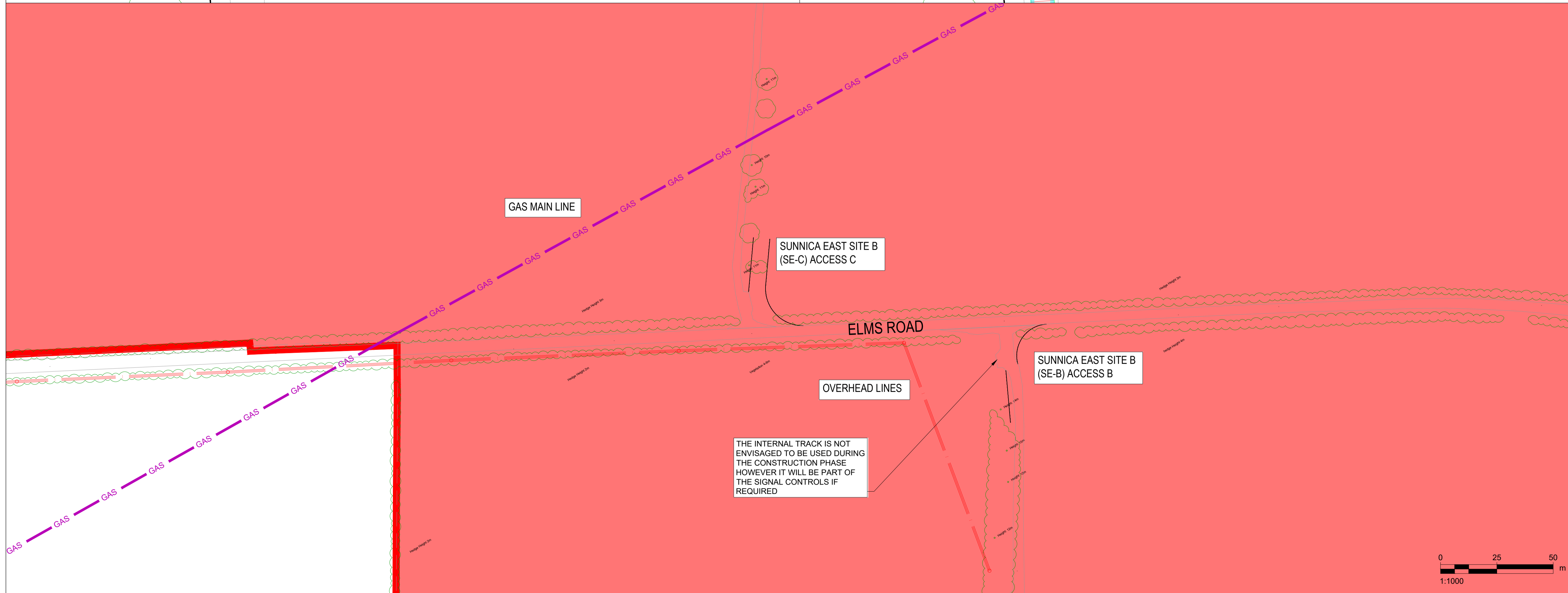
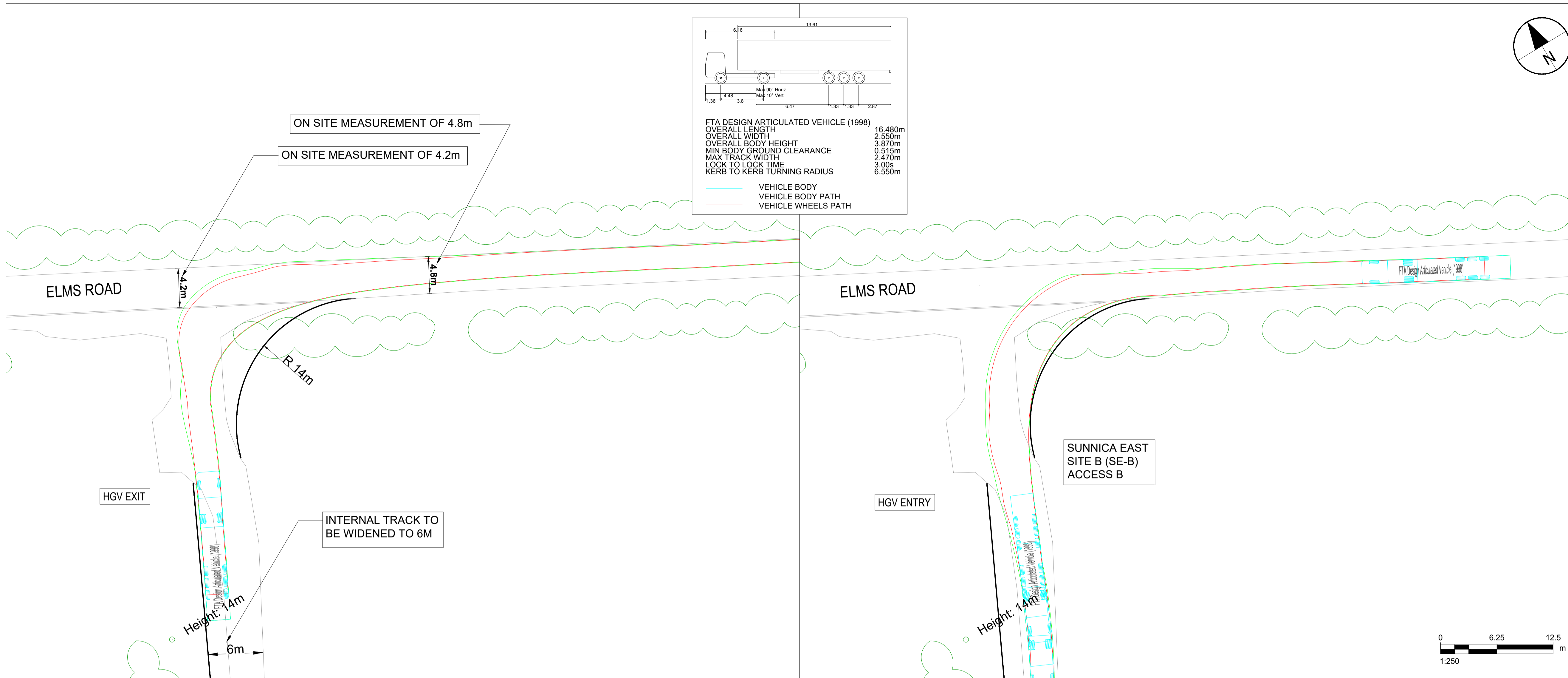

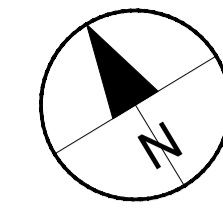

AECOM
AECOM House, 63-77 Victoria Street,
St. Albans, Hertfordshire, AL1 3ER
+44(0)1727 535000 tel
+44(0)1727 535099 fax
www.aecom.com

1. ALL DIMENSIONS ARE IN METRES UNLESS NOTED OTHERWISE
2. ALL JUNCTION LAYOUTS AREA INDICATIVE
3. DESIGN BASED ON TOPOGRAPHIC SURVEY UNDERTAKEN BY "ABOVE SURVEYING" IN APRIL 2019.
4. ORDER LIMITS ARE TO THE OUTER EDGE OF THE RED LINE, WHICH IS AS PER PUBLISHED IN THE DCO DOCUMENTATION.
5. ON-SITE MEASUREMENTS RECORDED BY AECOM ON 05/08/2022.

- INDICATIVE JUNCTION LAYOUT
- VEGETATION REMOVAL REQUIRED
- TEMPORARY TRAFFIC SIGNALS
- ACHIEVABLE SITE ACCESS VISIBILITY

TRAFFIC REGULATION MEASURES
TO PROVIDE SAFE ENTRY AND EGRESS OF THE SITE ACCESS, TEMPORARY TRAFFIC SIGNALS AND TEMPORARY SPEED LIMIT REDUCTIONS ARE PROPOSED WHILST THE SITE ACCESS IS IN USE DURING THE CONSTRUCTION PERIOD. THESE ARE SHOWN ON SHEET NUMBER 60589004-TRM-TM-012 AND 60589004-TRM-TM-013 IN THE TRAFFIC REGULATION MEASURES PLAN TEMPORARY MEASURES.

I/R	DATE	DESCRIPTION
B	2022-11-28	MINOR UPDATE DEADLINE 3A
A	2022-11-11	FIRST ISSUE



60589004

SUNNICA EAST SITE B,
SITE ACCESS B (SE-B),
TEMPORARY TRAFFIC SIGNALS
AND VISIBILITY
SHEET NUMBER

